

# CT6700

# CT6701

# HIOKI

## Instruction Manual

# CURRENT PROBE

**EN**

Nov. 2015 Revised edition 2  
CT6700A981-02 15-11H





# Contents

Introduction.....	1
Verifying Package Contents .....	1
Safety Notes.....	2
Usage Notes.....	5

## **1 Overview 23**

1.1 Product Overview.....	23
1.2 Features .....	24
1.3 Parts Names and Functions.....	25
1.4 Measurement Workflow .....	30

## **2 Measurement Procedure 33**

2.1 Inspection Before Use .....	33
2.2 Preparation for Measurements .....	35
Connecting the device to the Power Supply .....	35
Performing Demagnetizing and Zero-Adjustment.....	37
2.3 Performing Measurements.....	41

## **3 Specifications 45**

3.1 Product Specifications .....	45
3.2 Functions .....	54

## **4 Maintenance and Service 57**

4.1 Troubleshooting .....	58
4.2 Error .....	61
4.3 Cleaning .....	63
4.4 Discarding the Device.....	64



## Introduction

Thank you for purchasing the HIOKI CT6700, CT6701 Current Probe. To obtain maximum performance from the device, please read this manual first, and keep it handy for future reference.

## Verifying Package Contents

When you receive the device, inspect it carefully to ensure that no damage occurred during shipping. In particular, check the accessories, panel keys, and connectors. If damage is evident, or if it fails to operate according to the specifications, contact your dealer or Hioki representative.

Check the package contents as follows.

**CT6700, CT6701 Current Probe**

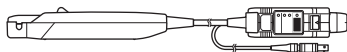

**Carrying Case**

**Instruction Manual**

**(The product ships with the current probe and instruction manual stored in the carrying case.)**

### Precautions during shipment

- Use the original packing materials when transporting the device, if possible.
- Transport the device in its carrying case.

### Options (sold separately)

The following options are available for the device. Contact your authorized Hioki distributor or reseller when ordering.

- Model 3269 Power Supply
- Model 3272 Power Supply

## Safety Notes

This device is designed to conform to IEC 61010 Safety Standards, and has been thoroughly tested for safety prior to shipment. However, using the device in a way not described in this manual may negate the provided safety features. Before using the device, be certain to carefully read the following safety notes.

### DANGER



**Mishandling during use could result in injury or death, as well as damage to the device. Be certain that you understand the instructions and precautions in the manual before use.**







### WARNING



**With regard to the electricity supply, there are risks of electric shock, heat generation, fire, and arc discharge due to short circuits. If persons unfamiliar with electricity measuring device are to use the device, another person familiar with such devices must supervise operations.**

## Notation

In this manual, the risk seriousness and the hazard levels are classified as follows.

 <b>DANGER</b>	Indicates an imminently hazardous situation that will result in death or serious injury to the operator.
 <b>WARNING</b>	Indicates a potentially hazardous situation that may result in death or serious injury to the operator.
 <b>CAUTION</b>	Indicates a potentially hazardous situation that may result in minor or moderate injury to the operator or damage to the device or malfunction.
<b>IMPORTANT</b>	Indicates information related to the operation of the device or maintenance tasks with which the operators must be fully familiar.
	Indicates a high voltage hazard. If a particular safety check is not performed or the device is mishandled, this may give rise to a hazardous situation; the operator may receive an electric shock, may get burnt or may even be fatally injured.
	Indicates prohibited actions.
	Indicates the action which must be performed.
*	Additional information is presented below.
<b>Bold</b>	Device's keys are indicated in boldface.

## Symbols affixed to the device



Indicates cautions and hazards. When the symbol is printed on the device, refer to a corresponding topic in the Instruction Manual.



Indicates that only insulated conductors suited to the voltage of the circuit under test can be measured.

## Symbols for various standards



WEEE marking:

This symbol indicates that the electrical and electronic appliance is put on the EU market after August 13, 2005, and producers of the Member States are required to display it on the appliance under Article 11.2 of Directive 2002/96/EC (WEEE).



This symbol indicates that the product conforms to regulations set out by the EC Directive.

## Accuracy

We define measurement tolerances in terms of rdg. (reading) with the following meanings:

**rdg.**

rdg. (reading or displayed value)

The value currently being measured and indicated on the measuring device.



## Usage Notes

Follow these precautions to ensure safe operation and to obtain the full benefits of the various functions.

### DANGER



To avoid electric shock, do not remove the device's cover. The internal components of the device carry high voltages and may become very hot during operation.

### WARNING



- Before using the device, make sure that the insulation on the cord is undamaged and that no bare conductors are improperly exposed. Using the device in such conditions could cause an electric shock, so contact your dealer or Hioki representative for repair.
- Before using the device, Verify that it operates normally to ensure that no damage occurred during storage or shipping. If you find any damage, contact your dealer or Hioki representative.

### CAUTION



Be careful to avoid dropping the device or otherwise subjecting them to mechanical shock, which could damage the facing surfaces of the core and adversely affect measurement.

## Installation

For details on the operating temperature and humidity, see the “3 Specifications” (p.45).

### **WARNING**



- **Avoid the following locations that could cause an accident, fire, or damage to the device.**
  - **Exposed to direct sunlight or high temperature**
  - **Exposed to corrosive or combustible gases**
  - **Exposed to water, oil, chemicals, or solvents**
  - **Exposed to high humidity or condensation**
  - **Exposed to a strong electromagnetic field or electrostatic charge**
  - **Exposed to high quantities of dust particles**
  - **Near induction heating systems (such as high-frequency induction heating systems and IH cooking equipment)**
  - **Susceptible to vibration**
  - **Located near a device that uses high-frequency power**

**Avoid obstructing the ventilation holes on the sides and bottom of the terminator (p.25), as it could overheat and be damaged, or cause a fire.**

### **CAUTION**



- **Do not place the device on an unstable table or an inclined place. Dropping or knocking down the device can cause injury or damage to the device.**

## Precautions during preparation for measurements

### WARNING



**To avoid shock and short circuits, turn off all power before connecting the device.**

### CAUTION



- Before turning on the power, make sure that the voltage of the power supply being used matches the supply voltage indicated on the rear panel of optional Model 3269 or Model 3272 Power Supply.
- Check that the conductor being measured is not clamped when supplying power to the device. A demagnetizing waveform may be generated when power is supplied, causing damage to components connected to the circuit being measured.
- To avoid terminator (p.25) damage, keep it oriented in a straight line relative to the waveform measurement instrument when connecting and disconnecting it.

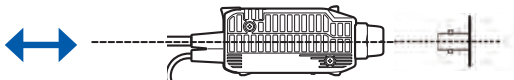

- To avoid damaging the output connector, pull the unlock lever toward you and then pull the connector out and away from the waveform measurement instrument.

 **CAUTION**

- When connecting an input connector other than a BNC connector, for example a conversion plug, do so such that the BNC center conductor is positive and other metallic parts are ground potential (or negative).

**Reference**

- Device output is terminated internally. Since the output resistance is  $50\ \Omega$ , the device must be used with a waveform measurement instrument (oscilloscope, recorder, etc.) that has an input impedance of at least  $1\ \text{M}\Omega$ . Accurate measurement is not possible with waveform measurement instruments that have an input resistance of  $50\ \Omega$ .
- An AC voltage waveform may appear in the output under certain circumstances, even under conditions of no input, if the device is connected to the 3269 or the 3272 Power Supply while the power supply is on. This does not indicate a malfunction. The AC voltage waveform that appeared in the output will disappear, and operation restored to normal by opening and closing the sensor head.

**Reducing the impact of offset drift\***

- Wait at least 30 minutes after turning on the device before making measurements. Offset drift may increase immediately after power is supplied to the probe due to self-heating and other factors.
- Offset drift will occur when the ambient temperature changes or when the device is used to make continuous measurements over an extended period of time, causing measured values to include an error component. Perform demagnetization and zero-adjustment as necessary.

\*A phenomenon whereby the magnitude of the zero point error component (offset voltage) varies over time.

## Precautions during measurement

### DANGER



- Do not measure around a bare conductor. Doing so may result in short-circuit or electric shock. Take measurements at a location on an insulated wire where there is sufficient insulation for the circuit voltage.



- Refer to the derating characteristics when measuring current that includes a high-frequency component and never measure any current that exceeds the rated current. Use with high frequencies or strong magnetic fields may cause the device to become abnormally hot, resulting in fire, equipment damage, or burns. (See “3 Specifications” (p.45).)
- Observe the following to avoid electric shock and short circuits.
  - Connect the device to the 3269 or the 3272 Power Supply and waveform measurement instrument (oscilloscope or recorder) first, and then to the active lines to be measured.
  - When the sensor is opened, do not short-circuit the conductor being measured or other two wires with the metal part of the tip.

**⚠ DANGER**

- **When using a measurement instrument that does not provide isolation between its input terminals and chassis or other input terminals, please pay attention to the following points. The device's reference potential is the ground potential. Do not apply a different potential to the ground side of other input connectors. Otherwise, short-circuit current will flow through the 3269, or the 3272 or this device from the ground terminal, which could cause an electrical accident or damage.**

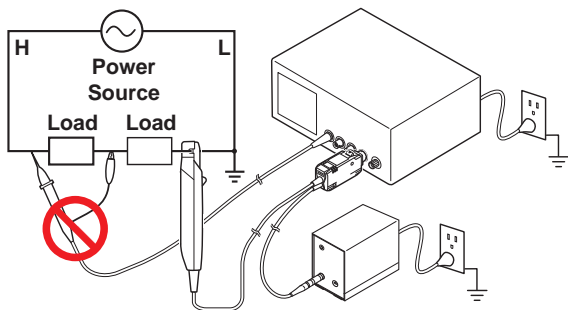



## DANGER

- To prevent fire or damage of the measurement target and device as well as burns, exercise caution concerning the following when measuring high-frequency currents or currents that contain high-frequency components:
  - Eddy current loss may cause heating of the sensor head.
  - Dielectric heating may cause heating of cord insulation and other materials.
- Be sure to observe all operating precautions for the waveform measurement instrument and other measurement instruments to which this device is connected.
- This device should only be connected to the secondary side of a breaker, so the breaker can prevent an accident if a short circuit occurs. Connections should never be made to the primary side of a breaker, because unrestricted current flow could cause a serious accident if a short circuit occurs.
- Before clamping the conductor being measured, make sure that the insulation on the conductor is undamaged. Also, take care not to damage the insulation when clamping the conductor. Any damage to the insulation could cause an electric shock.





**⚠ WARNING**

- Do not press and hold the **DEMAG/AUTO ZERO** key to perform demagnetization while the conductor being measured is clamped. Doing so could damage the circuitry or cause an accident that might result in injury or death.

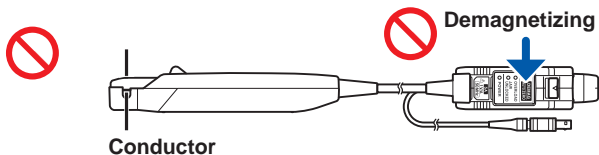

- Ensure that the input does not exceed the maximum rated current to avoid device damage, shortcircuiting and electric shock resulting from heat building.

**⚠ CAUTION**

- To avoid damage to the output connector on the terminator or the BNC input terminal's locking mechanism on the waveform measuring instrument, do not rotate with both terminals connected. Additionally, exercise care to ensure that connections are not subject to stress.

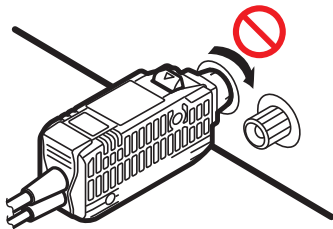

- Do not place foreign objects between the mating faces of the sensor head, insert foreign objects into the gaps of the sensor head, or touch the mating faces. Doing so may worsen the performances of the sensor or interfere with clamping action.
- Do not apply a static electricity or other source of high voltage to the sensor. Doing so may damage its internal Hall elements and circuitry.
- Do not short-circuit the output terminal and do not input voltage to the output terminal. The device may be damaged.
- Note that the device may be damaged if the applied current exceeds the measurement range.

**⚠ CAUTION**

- When the 3269, 3272 Power Supply or waveform measurement instrument's power is turned off, do not apply current to the device. Doing so may damage the device, the 3269, 3272 Power Supply and/or waveform measurement instrument.
- Do not place any unclamped conductor with an electric current of a frequency of 10 kHz or more near the sensor head. Current flowing in the conductor nearby may heat up the sensor head and cause its temperature to rise, leading to damage to the device. For example, when one side of a go-and-return conductor is clamped and the other side is also placed near the sensor head as shown in the diagram, even if the electric current is lower than the maximum rated current, electric currents in both sides will heat up the wires and raise the temperature, thereby causing damage to the device.

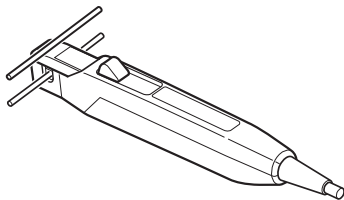

- The maximum rated current is based on heat that is internally generated during measurement. Never input current in excess of this level. Exceeding the rated level may result in damage to the device.

 **CAUTION**

- The device may sustain damage from self-heating even at current levels that are lower than the maximum current value defined by the maximum rated current.

The maximum rated current is a recommended value that assumes sine-wave input under standard conditions. Self-heating may increase if the ambient temperature increases or the measurement current waveform contains other frequency components. Refer to the derating characteristics in the product specifications (p.50).



- The product specifications that indicate the maximum input range include a maximum peak current value of  $\pm 7.5$  A peak (non-continuous) in addition to the maximum rated current. This value constitutes an absolute upper limit that must never be exceeded, even momentarily. Always use the device within the specified range in order to avoid damaging it.
- The detection frequency band for overload warnings is DC and 45 to 66 Hz (sine wave). When measuring currents that are outside the detection frequency band, the overload warning function may not operate. Under such conditions, exercise caution so as not to exceed the maximum rated current, regardless of whether the **OVERLOAD** LED is flashing.

## ⚠ CAUTION

- When opening the sensor head, always operate the opening lever. Subjecting the sensor head to force from the directions shown in the figure while it is locked may damage the clamping mechanism.

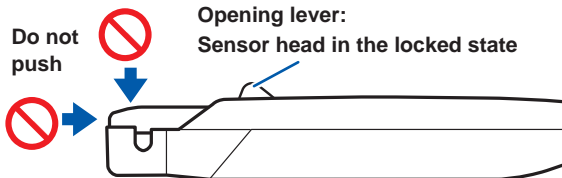

- Keep the sensor head closed when not in use, to avoid accumulating dust or dirt on the facing core surfaces, which could interfere with clamp performance.
- The sensor head is a precision assembly including a molded component, a ferrite core, and a Hall effect element. To prevent damage, avoid abrupt temperature changes, mechanical shock, static electricity, and other problematic phenomena.
- The matching surfaces of the sensor head are precisely ground, and should be treated with care. If these surfaces are scratched, performance may be impaired.
- Lock the sensor head while the **POWER** LED is on (except when clamping the conductor being measured). Leaving the sensor head open may damage the device.

 **CAUTION**



- Inputting a current in excess of the maximum rated current\* can cause heating of the device, resulting in device damage, a short-circuit, or electric shock. Remove the device from the conductor being measured immediately. The device must be allowed to cool adequately before resuming normal use.

\*: The maximum rated current varies according to the frequency of the current being measured. See the figures as follows:  
“Fig.3 Derating according to frequency (CT6700)” (p.50),  
“Fig.4 Derating according to frequency (CT6701)” (p.50)

## Reference

- When using the device, note that two current sensors may not be used simultaneously with the 3272 Power Supply, depending on the current to be measured.
- The current consumption of the device depends on the current to be measured. Confirm that the total current consumption of the device does not exceed the rated output current of the 3272. When using the 3272, confirm that the total current consumption of the device does not exceed the rated output current of the 3272.

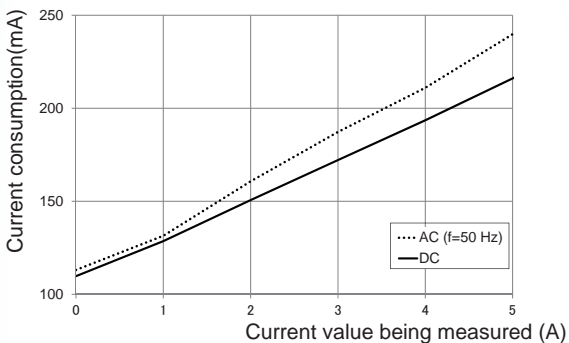

Current consumption\* vs. current to be measured (typical)

\*The sum total of a positive and negative current consumption

## Reference

- To measure DC or low-frequency current, multiple windings may be used to increase relative sensitivity (10 windings multiplies the measured current by a factor of 10). However, in this case, the windings should be made radially, with a diameter of at least 20 cm.

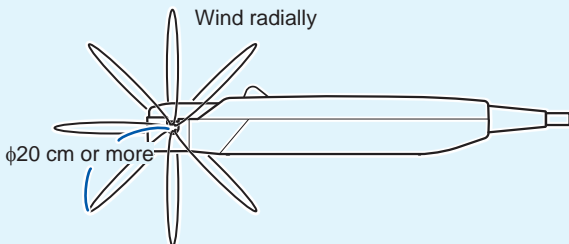

- The measurement may be affected by the position within the sensor aperture of the conductor being measured. The conductor should be in the center of the sensor aperture, and the straight portion should be as long as possible. Avoid positioning the conductor so that it is wound locally around the sensor head.
- To facilitate accurate measurement, press the opening lever until the **JAW UNLOCKED** indicator turns off before making a measurement to ensure that the sensor head is securely closed and locked.
- Cord placement and the act of clamping the probe onto the conductor being measured may trigger load fluctuations, affecting the observed waveform.



## Reference

- At high frequencies, common mode noise may affect measurements taken on the high voltage side of circuits. If this occurs, reduce the frequency range of the waveform measurement instrument, or clamp onto the low-voltage side of the circuit, as appropriate.

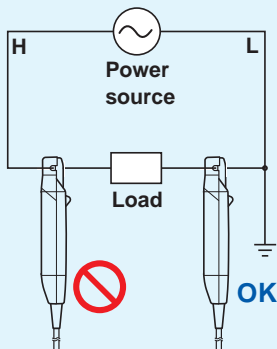

- Depending on the amplitude and frequency of the current being measured, the sensor head may emit a resonant sound. This sound may also occur during demagnetizing operation, but it does not represent a malfunction (device failure).
- If foreign matter becomes adhered to the facing surfaces on the sensor head so that a slight gap exists between the upper and lower sensors, the sensor head may emit a resonant sound. Any foreign matter should be removed using the cleaning method described in this manual (see “4.3 Cleaning” (p.63)).

## Reference

- An increase in the volume of the resonant sound during use may indicate that the gap between the upper and lower sensors has increased in size. Since the sensor characteristics may change, it is recommended to calibrate the device (see “4 Maintenance and Service” (p.57)).

## Precautions after measurement

### CAUTION



- To prevent wire breaks, do not pull on the cord to disconnect the output connector from the waveform measurement instrument. Always grip the terminator and pull the unlock lever toward you before disconnecting the connector.



- Observe the following precautions when disconnecting the device in order to prevent wiring breaks in the device's power cord or damage to the 3269 or 3272 Power Supply receptacle:
  - Grip the power supply plug's shell (p.25) when disconnecting it.
  - Do not pull on cords to disconnect them or twist the power supply plug. (Pulling on the power supply plug's shell causes the lock to be released so that it can be disconnected from the power supply receptacle.)

# 1 Overview

## 1.1 Product Overview

This device can be directly connected to a BNC input connector of a waveform measurement instrument such as an oscilloscope or recorder, and by clamping on a conductor being measured, allows the current waveform to be easily captured.

## 1.2 Features

- The sensor head<sup>\*1</sup> has a clamp design that makes it possible to easily observe current waveforms while current continues to flow through the conductor being measured.
- The sensor head features a sliding opening and closing mechanism<sup>\*2</sup> that is easy to operate.
- The terminator's<sup>\*3</sup> output connector can be easily connected to a waveform measurement instrument simply by plugging it in<sup>\*4</sup>.
- The terminator's output connector can be connected when the locking pin on the waveform measurement instrument's BNC input connector is in either the horizontal or vertical orientation<sup>\*4</sup>.
- LED warnings are displayed when an overload occurs and when the sensor head is unlocked.<sup>\*5</sup>
- You can observe low-current waveforms at the high sensitivity of 1 V/A.<sup>\*6</sup>
- Broadband frequency characteristics<sup>\*6</sup>  
CT6700: DC to 50 MHz  
CT6701: DC to 120 MHz
- Demagnetization and zero-adjustment functions make it easy to get ready for measurement.<sup>\*7</sup>

\*1: See "Sensor" (p. 26)

\*2: See Procedure 2 (p. 41)

\*3: See "Terminator" (p. 25)

\*4: See Procedure 3 (p. 39)

\*5: See "Key and LEDs" (p. 28)

\*6: See "3 Specifications" (p. 45)

\*7: See "Performing Demagnetizing and Zero-Adjustment" (p. 37)

## 1.3 Parts Names and Functions

### Terminator

#### Output connector

The current waveform of the measured conductor is output at a constant rate (1 V/A).

Connect to the BNC input connector of the waveform measurement instrument.



See p. 7 and p. 14.

#### Unlock lever

The output connector can be disconnected by pulling this part toward you.

#### Key and LEDs (p. 28)



See p. 10.

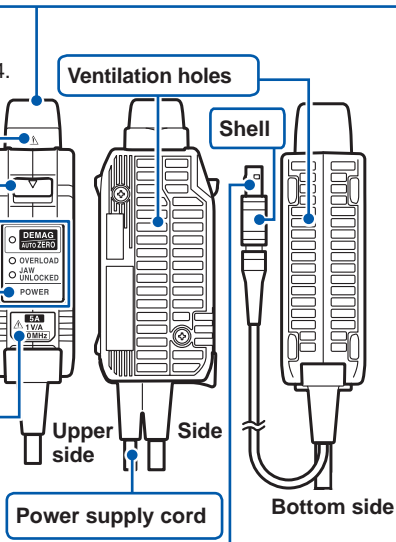

#### Power plug

Connect this to the 3269 or the 3272 Power Supply to supply power to the sensor terminator.

## Sensor

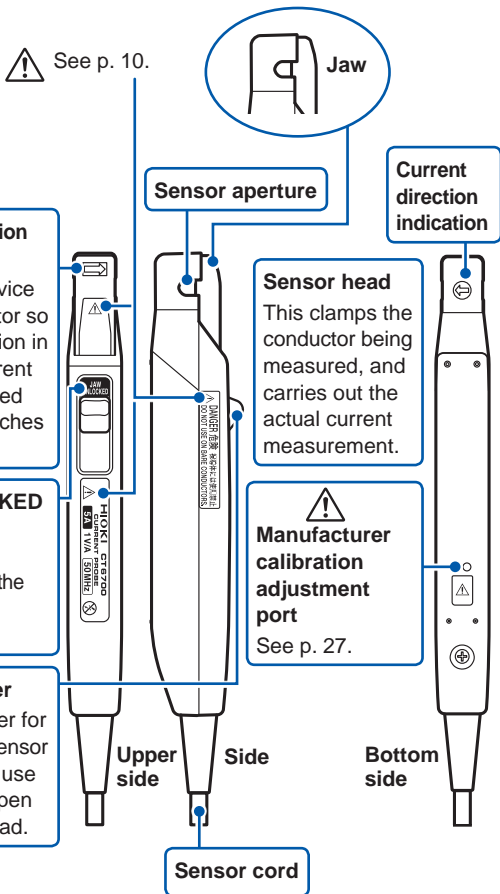

 **CAUTION**

- There is an adjustment port that is used for manufacturer calibration purposes on the bottom of the device's sensor. This adjustment port is used during the manufacturer calibration process. To prevent damage and measured value faults, do not insert or push foreign objects into the port or turn the adjustment knob.
- 



- To prevent sensor head damage, avoid abrupt temperature changes, stress, mechanical shock, application of static electricity, and other problematic phenomena.
-

## Key and LEDs

The key is used to perform demagnetization and zero-adjustment, while the LEDs indicate the device status.

### DEMAG/AUTO ZERO LED

Slow flashing orange:

Before demagnetization and zero-adjustment (when either can be performed), after an overload is detected, and when demagnetization could not be completed successfully

Lit up continuously, orange:

During demagnetization and zero-adjustment

Off:

After demagnetization and zero-adjustment

### DEMAG/AUTO ZERO key (p. 37)

Performs demagnetization and zero-adjustment.

#### Long press

(Approx. 1 sec.):

Demagnetization and zero-adjustment

#### Short press

(Within 0.5 sec.):

Zero-adjustment only

### JAW UNLOCKED LED

Lit up continuously, red:

When the sensor head is unlocked

### POWER LED

Lit up continuously, green: When energized

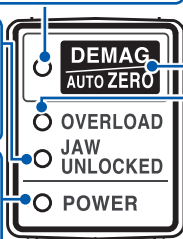

### OVERLOAD LED

Slow flashing red: There is no margin remaining until the maximum rated current.

Exercise care so as not to exceed the rating.

Fast flashing red: The rating is being exceeded.

Remove the sensor from the measurement target immediately.



## LED on/flashing specifications

●: Lit up, ▲: Flashing slowly (Approx. 1 time/second), △: Flashing quickly (Approx. 4 times/second), —: Off

Device state	At power on	Normal state after startup	During demagnetization and zero-adjustment	Normal state before use	While sensor head unlocked	During overload	During overload with sensor head unlocked	Malfunction <sup>*2</sup>	Malfunction <sup>*3</sup>	Malfunction <sup>*4</sup>
Function status										
Demagnetizing and zero-adjustment		Before	In progress	Complete						
Overload detected		None	None	None	None	Greater than prescribed level 1 <sup>°</sup>	Greater than prescribed level 2 <sup>°</sup>	Greater than prescribed level 1 <sup>°</sup>	Greater than prescribed level 2 <sup>°</sup>	
Sensor head lock state		Locked	Locked	Locked	Unlocked	Locked	Unlocked	Unlocked		
LED										
DEMAG/AUTO ZERO	● 1 s ▲	▲	●	—	— <sup>*1</sup>	— <sup>*1</sup>	— <sup>*1</sup>	— <sup>*1</sup>	△	△
OVERLOAD	● 1 s	—	—	—	—	▲	△	▲	△	△
JAW UNLOCKED	● 1 s	—	—	—	●	—	●	●	△	△
POWER	●	●	●	●	●	●	●	●	●	△

\*1: When the **JAW UNLOCKED** LED is lit up or the **OVERLOAD** LED is flashing, the **DEMAG/AUTO ZERO** LED will not be lit, even before demagnetization and zero-adjustment.

\*2: When the **DEMAG/AUTO ZERO** key is pressed while the **JAW UNLOCKED** LED is lit up or the **OVERLOAD** LED is flashing, or while a current value of 0.5 A rms or greater has been detecting.

(Demagnetization and zero-adjustment are disabled.)

\*3: When an internal temperature anomaly is detected. (Pressing the **DEMAG/AUTO ZERO** key after removing the device from the target conductor and waiting for it to cool off will return the device to its normal state after starting up.)

\*4: CPU malfunction (Checksum error). (Have the device repaired.)

\*5: Greater than prescribed level 1 (Rating warning): Approx. 4.75 A rms (DC, 45 to 66 Hz sine wave)  
Greater than prescribed level 2 (Rating exceeded): Approx. 5.25 A rms (DC, 45 to 66 Hz sine wave)

## 1.4 Measurement Workflow

Before using the device, be sure to review the “Usage Notes” (p. 5) and operating procedures.

### Inspection Before Use (p. 33)



### Preparation for Measurements

#### Connecting the device to the power supply. (p. 35)

1 Verify that the 3269 or 3272 is turned off and connect the power cord to the AC electrical outlet.



2 Lock the device's sensor head.



3 Connect the power plug of the device to the 3269 or the 3272.



4 Turn the 3269 or the 3272 power switch on.



5 Wait at least 30 minutes after turning on the device.



#### Performing Demagnetizing and Zero-Adjustment. (p. 37)

1 Adjust the waveform measurement instrument's zero position and set its input coupling.



**2** Connect the device's output connector to the waveform measurement instrument.

**3** Press and hold the **DEMAG/AUTO ZERO** key.

(At this time, do not clamp the conductor being measured.)

### Performing Measurements. (p. 41)

---

---

**1** Clamp the device around the conductor being measured.

**2** Lock the device's sensor head.

**3** Observe the current waveform with a waveform measurement instrument.

### Finishing Measurements. (p. 43)

---

---

**1** Remove the device from the conductor being measured.

**2** Disconnect the device from the waveform measurement instrument.

**3** Turn the 3269 or the 3272 power switch off.

**4** Disconnect the device's power plug from the 3269 or 3272.



- 5** Unplug the 3269 or 3272 power cord from the electrical outlet.

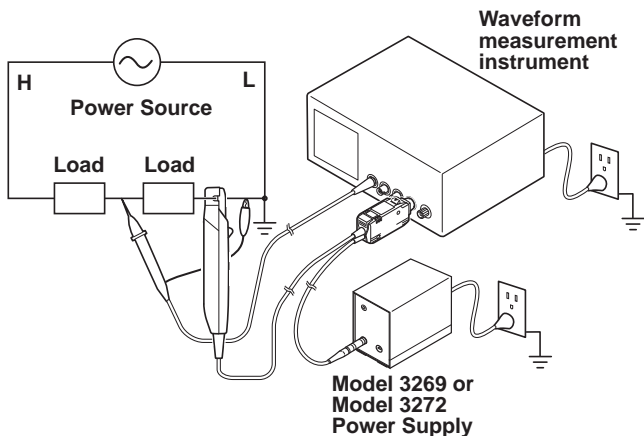

### Reference

The above figure illustrates an example connection between the device and a normal oscilloscope or other instrument that does not have isolated input terminals. Connect the device as appropriate for the target circuit and the waveform measuring instrument being used.

**2****Measurement Procedure****2.1 Inspection Before Use**

Before using the device for the first time, verify that it operates normally to ensure that no damage occurred during storage or shipping. If you find any damage, contact your authorized Hioki distributor or reseller.

See: “Before sending the device for repair” (p. 59)

## Visual check of device and conductor being measured Operation check

Check Item		Action	
1	Is the sensor cracked or damaged?	Yes →	Do not use if damage is present, and return the device for repair. This may cause an electric shock.
	↓ No		
2	Is the insulation on the cord damaged?	Yes →	
	↓ No		
3	Do all the LEDs light up for 1 second after the device is powered on (p. 35)?	No →	The device is broken and should be repaired if the LEDs do not light up or if all LEDs continue to flash.
	↓ Yes		
4	Is the insulation of the conductor being measured damaged?	Yes →	Do not clamp the conductor to avoid an electric shock.
	↓ No		
Inspection complete			

## 2.2 Preparation for Measurements

Before preparation for measurements, be sure to read “Precautions during preparation for measurements” (p. 7).

### Items to be prepared

- Model CT6700 or Model CT6701 Current Probe
- Model 3269 or Model 3272 Power Supply (option)
- Waveform measurement instrument (oscilloscope, recorder, or etc.)

### Connecting the device to the Power Supply

#### Procedures

- 1 Verify that the **POWER** switch on the 3269 or 3272 is in the OFF position and connect the power cord.

- 2 To lock the sensor head, push the opening lever until the **JAW UNLOCKED** indication disappears.

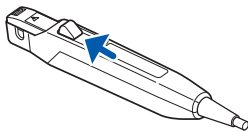

At the moment, do not clamp the conductor being measured.

Connect the power plug of the device to the power receptacle of the 3269 or the 3272.

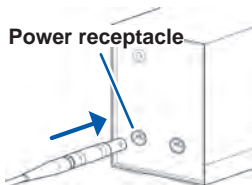

### 3 Turn the 3269 or 3272 **POWER** switch on.

Verify the following:

Model 3269 or  
3272 Power  
Supply



The front panel **POWER** indicator light.

After all LEDs light up for 1 second, they behave as follows:

Model CT6700  
or CT6701



Flashing slowly

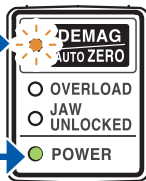

Lights up





- 
- 4 Wait at least 30 minutes after turning on the device.** Immediately after power is supplied, offset drift may increase due to the effects of self-heating of the device and other factors. To ensure accurate measurement, wait at least 30 minutes after turning on the device before performing measurement.
- 

## Performing Demagnetizing and Zero-Adjustment

---

Always carry out demagnetizing and zero-adjustment before measurement.

The demagnetizing and zero-adjustment process takes about 20 seconds.

### **What is "Demagnetizing"?**

Demagnetization is a function used to eliminate the magnetic charge of the magnetic core, which can result from turning the power on and off, excessively large input, or other factors.

### **What is "Zero-adjustment"?**

Zero-adjustment corrects offset voltage fluctuations caused by factors such as the device-specific characteristic offset voltage and temperature variations.

## Reference

- The DEMAG/AUTO ZERO LED flashes slowly after the device is turned on, after input in excess of a rating is removed, and until demagnetization and zero-adjustment are performed.
- During demagnetization (**while the DEMAG/AUTO ZERO LED is lit up**), the demagnetization waveform (a waveform that attenuates over time) will be output from the device's output connector and displayed on the waveform measurement instrument. The positive and negative components of this waveform may be asymmetrical, but this does not represent a device malfunction.
- If you wish to perform just zero-adjustment without performing demagnetization, press the **DEMAG/AUTO ZERO** key within 0.5 sec.
- To forcibly halt demagnetization or zero-adjustment while in progress, unlock the sensor head. You will need to repeat the demagnetization and zero-adjustment process according to the instructions later.

## Procedures

---

**1** Set the input coupling of the waveform measurement instrument to GND, adjust the zero position of the display.

---

**2** Set the input coupling of the waveform measurement instrument to DC.

---

**3** Connect the output connector of the device to the BNC input connector of the waveform measurement instrument.

Insert the connector until it clicks into place so that it is securely locked in position.

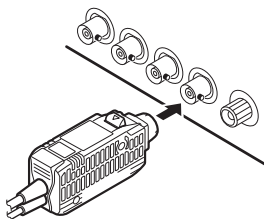

The device can be connected when the locking pin on the waveform measurement instrument's BNC input connector is in either the horizontal or vertical orientation.

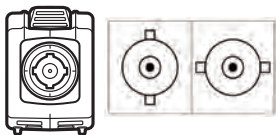

- 4 Press and hold the **DEMAG/AUTO ZERO** key for about 1 second.

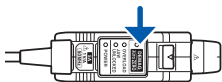

Do not press the key with excessive force.

Zero-adjustment will be performed after demagnetization.

### While performing demagnetization and zero-adjustment

The LED stops flashing and lights up continuously.

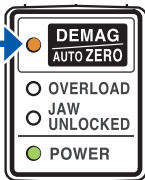

### After demagnetization and zero-adjustment complete normally

The LED turns off.

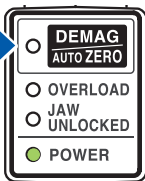

If the **DEMAG/AUTO ZERO** LED continues flashing instead of turning off when the **DEMAG/AUTO ZERO** key is pressed, demagnetization and zero-adjustment did not complete normally.

See “Demagnetization and zero-adjustment do not complete normally.” (p. 60).

## 2.3 Performing Measurements

Before performing measurements, be sure to read “Usage Notes” (p. 5), and “2.1 Inspection Before Use” (p. 33), and “2.2 Preparation for Measurements” (p. 35) and perform the described steps.

### Procedures

- 1 Pull the sensor opening lever, so that the sensor head opens.

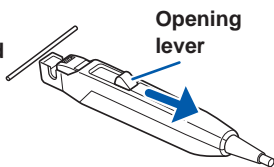

- 2 Clamp the conductor being measured.

- Clamp so that the conductor is in the center of the sensor aperture (p. 26).
- Align the sensor so that the current direction indication corresponds to the direction of current flow through the conductor to be measured.

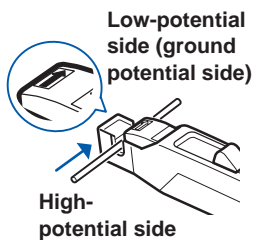

- 3** To lock the sensor head, push the opening lever until the **JAW UNLOCKED** indication disappears. The **JAW UNLOCKED** LED turns off.

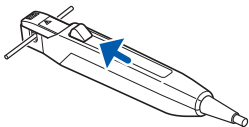

- 4** Monitor the current waveform with the waveform measurement instrument. The output rate of the device is 1 V/A. The current sensitivity can be derived from the voltage sensitivity of the waveform measurement instrument. For example, if the voltage sensitivity is 10 mV/division, the current sensitivity is 10 mA/division.

### Reference

- Offset voltage fluctuations of about 1 mV may occur when the sensor is opened or closed. To perform high-precision measurement, perform the steps listed below before clamping around the conductor being measured. Additionally, manipulate the lever gradually when closing the sensor and avoid subjecting the sensor head to large mechanical shocks. Abrupt manipulation of the lever may increase offset voltage fluctuations due to the shock it generates.
- 1** Wait about 5 minutes after the completion of demagnetization and zero-adjustment for offset drift to stabilize.
  - 2** Operate the opening lever four or five times to acclimatize the sensor.
  - 3** Press the **DEMAG/AUTO ZERO** key briefly to perform zero-adjustment only (do not press and hold the key).
- Do not subject the jaw or the opening lever to external force to prevent the occurrence of offset voltage fluctuations.

## Once measurement has completed

- 1 Pull the opening lever toward you and remove the device from the conductor being measured.

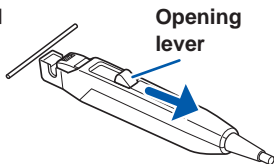

- 2 Disconnect the terminator from the waveform measurement instrument.

Pull the connector straight out while pulling the unlock lever toward you.

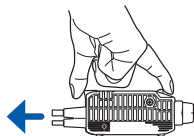

Terminator can be held using just two fingers, so it's easy to connect and disconnect them even if multiple sensors have been connected.

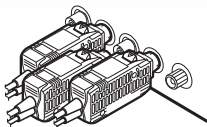

- 3 Turn the 3269 or the 3272 **POWER** switch off.

**4 Remove the power plug of the device from the 3269 or the 3272.**

- Grip the power supply plug's shell (p. 25) when disconnecting it.
- Do not pull on cords to disconnect them or twist the power supply plug.

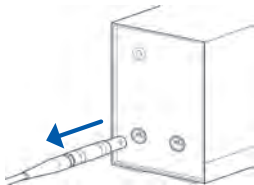

**5 Unplug the 3269 or 3272 power cord from the electrical outlet.**

---



# 3

## Specifications

### 3.1 Product Specifications

Accuracy and maximum rated current are guaranteed at  $23^{\circ}\text{C}\pm 5^{\circ}\text{C}$  ( $73^{\circ}\text{F}\pm 9^{\circ}\text{F}$ ) after the power has been on for 30 minutes.

Items	Model CT6700	Model CT6701
<b>Operating temperature and humidity range</b>	0°C to +40°C (32°F to 104°F) 80% RH or less (no condensation)	
<b>Storage temperature and humidity range</b>	-10°C to +50°C (14°F to 122°F) 80% RH or less (no condensation)	
<b>Location for use</b>	Indoor, pollution degree 2, altitude up to 2000 m (6562 ft.)	
<b>Frequency range</b>	DC to 50 MHz (-3dB) Representative characteristics: See Fig.1 (p. 49)	DC to 120 MHz (-3dB) Representative characteristics: See Fig.2 (p. 49)
<b>Rise time (10% to 90%)</b>	7.0 ns or less	2.9 ns or less

Items	Model CT6700	Model CT6701
<b>Maximum rated current</b>	5 A rms (DC, and sine wave) Derating according to frequency (Representative characteristics: See Fig.3 and 4 (p. 50)) Note: Depending on the terminator ambient temperature and measurement conditions, an overload may be caused by internal overheating, causing the maximum rated current to be less than 5 A rms.	
<b>Maximum peak current</b>	±7.5 A peak (non-continuous)	
<b>Output voltage rate</b>	1 V/A	
<b>Amplitude accuracy</b>	±3.0%rdg.±1 mV (typical ±1.0%rdg. ±1 mV) (DC, and sine wave 45 to 66 Hz, 0 to 5 A rms) Example representative waveform response during 1 mA measurement: See Fig.5 (p. 51) Note: The amplitude accuracy is not guaranteed if the state, which includes scratches and adhesion of foreign objects, of the mating faces as well as an operating environment change.	
<b>Output resistance</b>	50 Ω±10% (DC)	
<b>Noise</b>	75 μA rms or less (typical 60 μA rms) (for 30 MHz band measuring instrument)	

Items	Model CT6700	Model CT6701
<b>Temperature coefficient for sensitivity</b>	$\pm 2\%$ rdg. or less (After zero-adjustment with 50 Hz 5 A rms input, except at 23°C $\pm 5^\circ\text{C}$ [73°F $\pm 9^\circ\text{F}$ ])	
<b>Maximum rated power</b>	3.2 VA (with continuous maximum input)	
<b>Supply voltage</b>	$\pm 12\text{ V} \pm 0.5\text{ V}$	
<b>Effect of external magnetic fields</b>	20 mA or less (DC and 60 Hz, Magnetic field of 400 A/m)	5 mA or less (DC and 60 Hz, Magnetic field of 400 A/m)
<b>Effect of radiated radio-frequency electromagnetic field</b>	$\pm 10\text{ mA}$ or less at 3 V/m	
<b>Effect of conducted radio-frequency electromagnetic field</b>	$\pm 10\text{ mA}$ or less at 3 V	
<b>Measurable conductors</b>	Insulated conductor	
<b>Diameter of measurable conductors</b>	5 mm dia. or less (0.2" dia. or less)	

Items	Model CT6700	Model CT6701
<b>Accuracy warranty period</b>	1 year (Opening/closing up to 10000 times)	
<b>Product warranty period</b>	1 year	
<b>Cord lengths</b>	Sensor cord: 1.5 m $\pm$ 0.1 m (59.06" $\pm$ 3.94") Power supply cord: 1 m $\pm$ 0.1 m (39.37" $\pm$ 3.94")	
<b>External dimensions</b>	Sensor: Approx. 155W $\times$ 18H $\times$ 26D mm (approx. 6.10"W $\times$ 0.71"H $\times$ 1.02"D) (excluding protrusions) Terminator: Approx. 29W $\times$ 83H $\times$ 40D mm (approx. 1.14"W $\times$ 3.27"H $\times$ 1.57"D) (excluding output connector and protrusions)	
<b>Mass</b>	Approx. 250 g (approx. 8.8 oz.)	
<b>Accessories</b>	Instruction manual, Carrying case	
<b>Options</b>	<ul style="list-style-type: none"> <li>• 3269 Power Supply</li> <li>• 3272 Power Supply</li> </ul>	
<b>Standards Applying</b>	<ul style="list-style-type: none"> <li>• Safety EN61010</li> <li>• EMC EN61326</li> </ul>	

## Representative characteristics

### 1. Frequency Characteristics

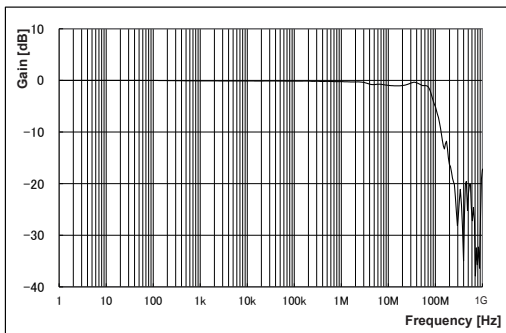

Fig.1 Frequency characteristics (typical) (CT6700)

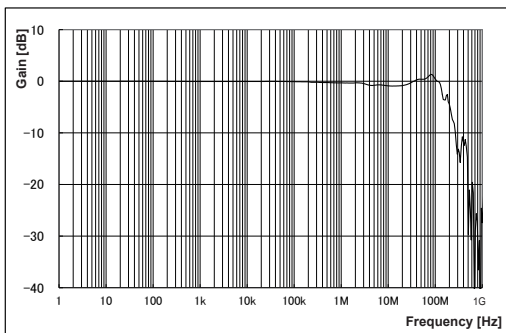

Fig.2 Frequency characteristics (typical) (CT6701)

## 2. Derating According to Frequency

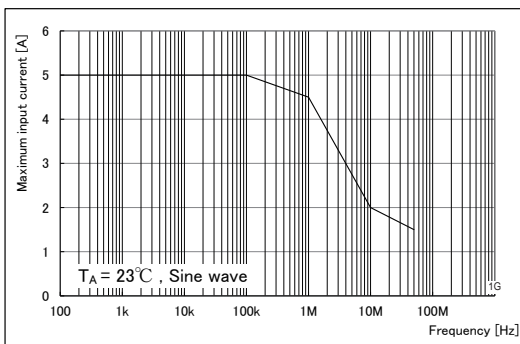

Fig.3 Derating according to frequency (CT6700)

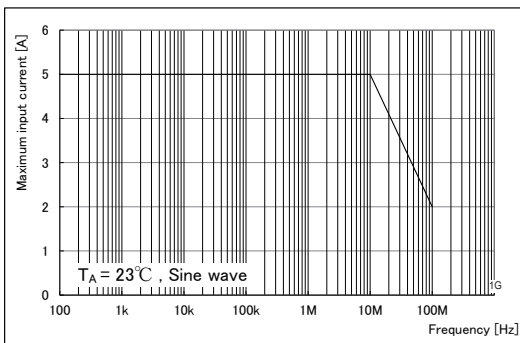

Fig.4 Derating according to frequency (CT6701)

## Reference

Figures 3 and 4 (p. 50), “Derating according to frequency,” assume operation at the temperature for which accuracy is defined and with sine-wave input.

If the ambient temperature ( $T_A$ ) rises or the current being measured contains a high-frequency component, the device’s temperature will rise, and the current value and frequency that can be continuously input will fall.

### 3. 1 mAp-p measurement waveform

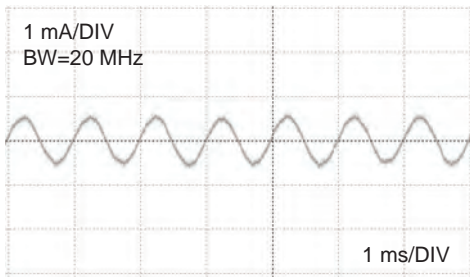

Fig.5 Example 1 mAp-p 1 kHz measurement waveform (CT6700)

#### 4. Input Impedance

The location at which the device has been clamped will exhibit the impedance (load) shown in Figures 6 and 7 below. It is especially important to take this data into account when performing high-frequency measurement.

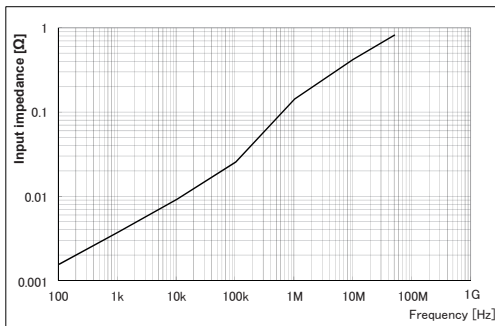

Fig.6 Input impedance (typical) (CT6700)

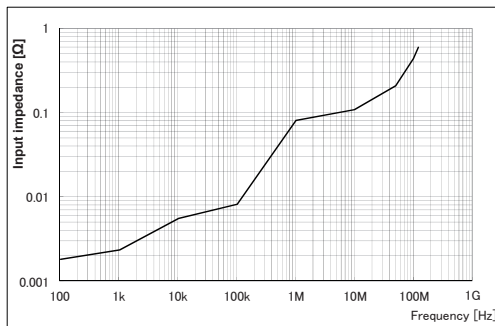

Fig.7 Input impedance (typical) (CT6701)



## 5. Effect on conductor being measured (inside sensor aperture) common-mode voltage

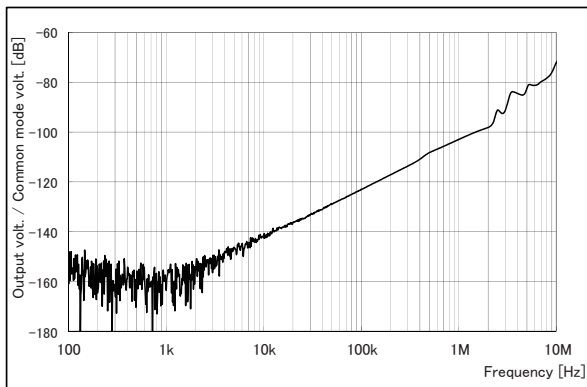

Fig.8 Effect of common-mode voltage (typical) (CT6700/CT6701)

## 3.2 Functions

### Demagnetizing and Zero-Adjustment Function

1. Demagnetizing and zero-adjustment
  - Operation:  
Performs demagnetization and zero-adjustment.
  - User action:  
Press and hold the **DEMAG/AUTO ZERO** key for at least 500 ms (typical).
2. Zero-adjustment
  - Operation:  
Performs zero-adjustment.
  - User action:  
Press and hold the **DEMAG/AUTO ZERO** key for at least 20 ms but less than 500 ms (typical).

---

Cannot be performed in the following circumstances:

- When the sensor head is unlocked (when the **JAW UNLOCKED** LED is lit up)
  - During an overload condition (when the **OVERLOAD** LED is flashing)
  - When a current measured value in excess of  $0.50 \pm 0.25$  A rms (DC, 45 to 66 Hz sine wave) is detected
-

---

**Demagnetizing and  
Zero-Adjustment  
Function****DEMAG/AUTO ZERO** LED

- Slow flashing orange:  
After the device is powered on, after input in excess of ratings is removed, or after demagnetization terminated abnormally
- Continuous orange:  
During demagnetization and zero-adjustment
- Off:  
After demagnetization and zero-adjustment

---

**Sensor head  
unlocked detection**

The **JAW UNLOCKED** LED will turn red (lighting up continuously) if the sensor head is not locked.

---

**Energization  
detection**

The **POWER** LED will turn green (lighting up continuously) when the device is energized.

---

---

**Overload detection** Sampling frequency: 7.8125 kHz (typical)  
Confirmation cycle : 500 ms (typical)  
(sampling: 400 ms (typical); calculation and judgment: 100 ms (typical))

---

1. Rating warning

- Indicates that the maximum rated current is about to be reached.
  - **OVERLOAD** LED: Red, slow flashing
  - Flashing conditions:  
If prescribed level 1 is exceeded
  - Prescribed level 1:  $4.75 \pm 0.25$  A rms (DC, 45 to 66 Hz sine wave)
- 

2. Rating exceeded

- Indicates that the maximum rated current has been exceeded.
  - **OVERLOAD** LED: Red, fast flashing
  - Flashing conditions:  
If prescribed level 2 is exceeded
  - Prescribed level 2:  $5.25 \pm 0.25$  A rms (DC, 45 to 66 Hz sine wave)
- 

3. Temperature exceeded

- Detects internal temperature anomalies.
  - Set temperature: 80°C (typical)
  - Hysteresis: 10°C (typical)
  - LED: All flashing except **POWER** LED
  - Recovery method:  
To return to initial state (state at power-on), remove the device from the conductor being measured, allow it to cool off, and press the **DEMAG/AUTO ZERO** key.
-

### WARNING



Ensure that the input does not exceed the maximum input voltage or current to avoid device damage, shortcircuiting and electric shock resulting from heat building.

### IMPORTANT

Periodic calibration is necessary in order to ensure that the device provides correct measurement results of the specified accuracy.

The calibration frequency varies depending on the status of the device or installation environment. We recommend that the calibration frequency is determined in accordance with the status of the device or installation environment and that you request that calibration be performed periodically.

## 4.1 Troubleshooting

- If damage is suspected, check the “Before sending the device for repair” (p. 59) section before contacting your authorized Hioki distributor or reseller.
- If no waveform is displayed even after performing demagnetization and zero-adjustment (p. 37), internal damage may have occurred. Contact your authorized Hioki distributor or reseller.
- If you must send the device out for repair, pack the device so that it will not sustain damage during shipping, and include a description of existing damage. We do not take any responsibility for damage incurred during shipping. (See “Precautions during shipment” (p. 1))

## Before sending the device for repair

Symptom	Check and/or remedy
<p><b>No waveform is displayed on the connected waveform measurement instrument</b></p>	<ul style="list-style-type: none"> <li>• Perform demagnetization and zero-adjustment again. (p. 37)</li> <li>• Verify that the waveform measurement instrument's input coupling parameter is set to DC. (p. 39)</li> </ul> <p>If this fails to remedy the issue, the device may be malfunctioning. Have it repaired.</p>
<p><b>A resonant sound is emitted by the sensor head.</b></p>	<p>A resonant sound may be emitted depending on the amplitude and frequency of the current being measured. Such a sound may also be emitted during demagnetization. Measurement is not affected.</p>
<p><b>The resonant sound emitted by the sensor head has grown louder.</b></p>	<p>The gap between the upper and lower sensors may have increased in size. It is recommended to calibrate the device since the gap may cause sensor characteristics to vary.</p>
<p><b>The positive and negative components of the demagnetization waveform are asymmetrical.</b></p>	<p>This is not a malfunction. Verify that the demagnetization and zero-adjustment process results in an appropriate zero position of the measurement waveform instrument.</p>

Symptom	Check and/or remedy							
<p><b>Demagnetization and zero-adjustment do not complete normally.</b></p>	<p>Demagnetization and automatic zero-adjustment cannot be performed in the following circumstances: Repeat demagnetization and zero-adjustment (p. 37) after implementing the suggested remedy.</p>							
	<table border="1"> <thead> <tr> <th data-bbox="436 433 698 481">Circumstances</th> <th data-bbox="698 433 930 481">Remedy</th> </tr> </thead> <tbody> <tr> <td data-bbox="436 481 698 732"> <p>When the <b>JAW UNLOCKED</b> LED is lit up</p> </td> <td data-bbox="698 481 930 732"> <p>Lock the sensor head. (Press the opening lever until the JAW UNLOCKED indicator turns off.)</p> </td> </tr> <tr> <td data-bbox="436 732 698 848"> <p>When the <b>OVERLOAD</b> LED is flashing</p> </td> <td data-bbox="698 732 930 965" rowspan="2"> <p>Disconnect the device from the conductor being measured.</p> </td> </tr> <tr> <td data-bbox="436 848 698 965"> <p>When a current of 0.5 A rms or greater has been detected</p> </td> </tr> </tbody> </table>	Circumstances	Remedy	<p>When the <b>JAW UNLOCKED</b> LED is lit up</p>	<p>Lock the sensor head. (Press the opening lever until the JAW UNLOCKED indicator turns off.)</p>	<p>When the <b>OVERLOAD</b> LED is flashing</p>	<p>Disconnect the device from the conductor being measured.</p>	<p>When a current of 0.5 A rms or greater has been detected</p>
	Circumstances	Remedy						
	<p>When the <b>JAW UNLOCKED</b> LED is lit up</p>	<p>Lock the sensor head. (Press the opening lever until the JAW UNLOCKED indicator turns off.)</p>						
<p>When the <b>OVERLOAD</b> LED is flashing</p>	<p>Disconnect the device from the conductor being measured.</p>							
<p>When a current of 0.5 A rms or greater has been detected</p>								
<p>If demagnetization and zero-adjustment do not complete normally even though no current is being measured, the device is broken and should be repaired.</p>								



## 4.2 Error

You can determine the nature of an error by observing the device's LED. When an error occurs, deal with it as described in the following table. If the device needs to be repaired, please contact your authorized Hioki distributor or reseller.

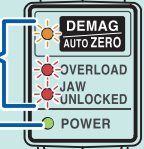
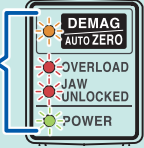
Error State	Solution
<p>LEDs continue to flash quickly.</p> <p>LED is lit up continuously.</p> 	<p>A temperature anomaly has been detected due to heating caused by an overload. Remove the device from the conductor being measured immediately. Allow the device to cool under conditions of no input and then press the <b>DEMAG/AUTO ZERO</b> key. The device will return to its state when it was turned on. Start measurement after performing demagnetization and zero-adjustment again. (p. 37)</p> <p>It is recommended to calibrate the device since internal components may have been subject to stress.</p>
<p>LEDs continue to flash quickly.</p> 	<p>An internal CPU malfunction (checksum error) has occurred. Have the device repaired.</p>

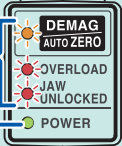
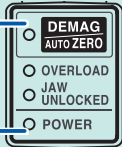
Error State	Solution						
<p>LEDs flash quickly three times</p> <p>LED is lit up continuously.</p> 	<p>This issue occurs when the <b>DEMAG/AUTO ZERO</b> key is pressed under the circumstances described in the table below.</p> <p>Demagnetization and automatic zero-adjustment cannot be performed. Perform demagnetization and zero-adjustment (p. 37) again after implementing the remedy described below.</p> <table border="1" data-bbox="456 569 930 1103"> <thead> <tr> <th data-bbox="456 569 684 617">Circumstances</th> <th data-bbox="684 569 930 617">Remedy</th> </tr> </thead> <tbody> <tr> <td data-bbox="456 617 684 838"> <p>When the <b>JAW UNLOCKED</b> LED is lit up</p> </td> <td data-bbox="684 617 930 838"> <p>Lock the sensor head. (Press the opening lever until the <b>JAW UNLOCKED</b> indicator turns off.)</p> </td> </tr> <tr> <td data-bbox="456 838 684 1103"> <p>When the <b>OVERLOAD</b> LED is flashing</p> <p>When a current of 0.5 A rms or greater has been detected</p> </td> <td data-bbox="684 838 930 1103"> <p>Remove the device from the conductor being measured.</p> </td> </tr> </tbody> </table>	Circumstances	Remedy	<p>When the <b>JAW UNLOCKED</b> LED is lit up</p>	<p>Lock the sensor head. (Press the opening lever until the <b>JAW UNLOCKED</b> indicator turns off.)</p>	<p>When the <b>OVERLOAD</b> LED is flashing</p> <p>When a current of 0.5 A rms or greater has been detected</p>	<p>Remove the device from the conductor being measured.</p>
Circumstances	Remedy						
<p>When the <b>JAW UNLOCKED</b> LED is lit up</p>	<p>Lock the sensor head. (Press the opening lever until the <b>JAW UNLOCKED</b> indicator turns off.)</p>						
<p>When the <b>OVERLOAD</b> LED is flashing</p> <p>When a current of 0.5 A rms or greater has been detected</p>	<p>Remove the device from the conductor being measured.</p>						
<p>All LEDs off even though the device is receiving power</p> 	<p>The device has malfunctioned. Have it repaired.</p>						

## 4.3 Cleaning

To clean the device, wipe it gently with a soft cloth moistened with water or mild detergent.

### IMPORTANT

Never use solvents such as benzene, alcohol, acetone, ether, ketones, thinners or gasoline, as they can deform and discolor the case.

### CAUTION



- Measurements are degraded by dirt on the facing surfaces of the sensor head, so keep the surfaces clean by gently wiping with a soft cloth.
- Before cleaning the facing surfaces on the sensor head, discharge any static electricity that may have built up on your hands by touching a nearby metal object. In this way you can ensure that a high voltage, for example caused by static electricity, will not be applied to the device. Application of a high voltage to the device may damage the internal Hall elements or circuitry.
- Clean the vents periodically to avoid blockage. If a vents becomes clogged, the devices internal cooling is impeded, and damage may result.

## 4.4 Discarding the Device

Handle and dispose of the device in accordance with local regulations.

## Warranty Certificate

Model	Serial No.	Warranty period One (1) year from date of purchase (___ / ___)
<p>This product passed a rigorous inspection process at Hioki before being shipped.</p> <p>In the unlikely event that you experience an issue during use, please contact the distributor from which you purchased the product, which will be repaired free of charge subject to the provisions of this Warranty Certificate. This warranty is valid for a period of one (1) year from the date of purchase. If the date of purchase is unknown, the warranty is considered valid for a period of one (1) year from the product's date of manufacture. Please present this Warranty Certificate when contacting the distributor. Accuracy is guaranteed for the duration of the separately indicated guaranteed accuracy period.</p> <ol style="list-style-type: none"><li>Malfunctions occurring during the warranty period under conditions of normal use in conformity with the Instruction Manual, product labeling (including stamped markings), and other precautionary information will be repaired free of charge, up to the original purchase price. Hioki reserves the right to decline to offer repair, calibration, and other services for reasons that include, but are not limited to, passage of time since the product's manufacture, discontinuation of production of parts, or unforeseen circumstances.</li><li>Malfunctions that are determined by Hioki to have occurred under one or more of the following conditions are considered to be outside the scope of warranty coverage, even if the event in question occurs during the warranty period:<ol style="list-style-type: none"><li>Damage to objects under measurement or other secondary or tertiary damage caused by use of the product or its measurement results</li><li>Malfunctions caused by improper handling or use of the product in a manner that does not conform with the provisions of the Instruction Manual</li><li>Malfunctions or damage caused by repair, adjustment, or modification of the product by a company, organization, or individual not approved by Hioki</li><li>Consumption of product parts, including as described in the Instruction Manual</li><li>Malfunctions or damage caused by transport, dropping, or other handling of the product after purchase</li><li>Changes in the product's appearance (scratches on its enclosure, etc.)</li><li>Malfunctions or damage caused by fire, wind or flood damage, earthquakes, lightning, power supply anomalies (including voltage, frequency, etc.), war or civil disturbances, radioactive contamination, or other acts of God</li><li>Damage caused by connecting the product to a network</li><li>Failure to present this Warranty Certificate</li><li>Failure to notify Hioki in advance if used in special embedded applications (space equipment, aviation equipment, nuclear power equipment, life-critical medical equipment or vehicle control equipment, etc.)</li><li>Other malfunctions for which Hioki is not deemed to be responsible</li></ol></li></ol> <p>*Requests</p> <ul style="list-style-type: none"><li>Hioki is not able to reissue this Warranty Certificate, so please store it carefully.</li><li>Please fill in the model, serial number, and date of purchase on this form.</li></ul> <p style="text-align: right;">13-09</p>		
<b>HIOKI E.E. CORPORATION</b> 81 Koizumi, Ueda, Nagano 386-1192, Japan TEL: +81-268-28-0555 FAX: +81-268-28-0559		





- Please visit our website at [www.hioki.com](http://www.hioki.com) for the following:
  - Regional contact information
  - The latest revisions of instruction manuals and manuals in other languages.
  - Declarations of Conformity for instruments that comply with CE mark requirements.
- All reasonable care has been taken in the production of this manual, but if you find any points which are unclear or in error, please contact your supplier or the International Sales and Marketing Department at Hioki headquarters.
- In the interests of product development, the contents of this manual are subject to revision without prior notice.
- The content of this manual is protected by copyright.  
No reproduction, duplication or modification of the content is permitted without the authorization of Hioki E.E. Corporation.

# HIOKI

---

HIOKI E. E. CORPORATION

## HEADQUARTERS

81 Koizumi, Ueda, Nagano 386-1192, Japan  
TEL +81-268-28-0562 FAX +81-268-28-0568  
[os-com@hioki.co.jp](mailto:os-com@hioki.co.jp)  
(International Sales Department)

## [www.hioki.com](http://www.hioki.com)

## HIOKI USA CORPORATION

[hioki@hiokiusa.com](mailto:hioki@hiokiusa.com) [www.hiokiusa.com](http://www.hiokiusa.com)

## HIOKI (Shanghai) SALES & TRADING CO., LTD.

[info@hioki.com.cn](mailto:info@hioki.com.cn) [www.hioki.cn](http://www.hioki.cn)

## HIOKI INDIA PRIVATE LIMITED

[hioki@hioki.in](mailto:hioki@hioki.in) [www.hioki.in](http://www.hioki.in)

## HIOKI SINGAPORE PTE. LTD.

[info@hioki.com.sg](mailto:info@hioki.com.sg)

1502EN